

Standing Cactus

By Wensdy Whitehead

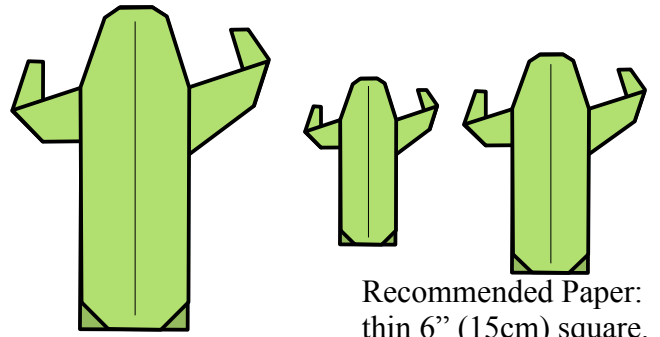

Recommended Paper:
thin 6" (15cm) square.

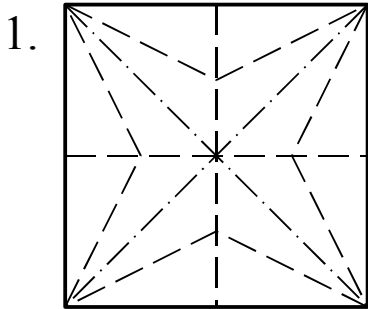

1. Start with a colorful bird base with the wings down.

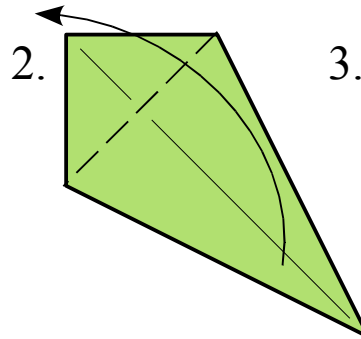
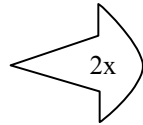

2. Fold one flap up.

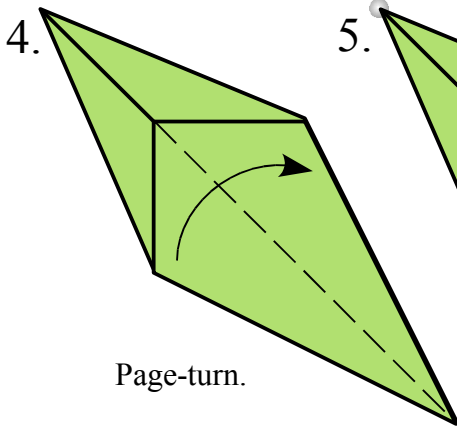
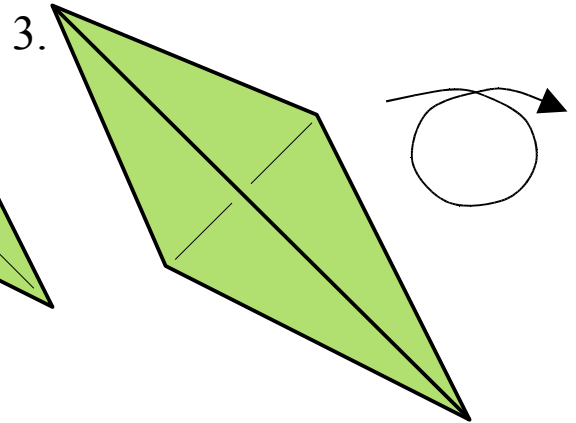

Page-turn.

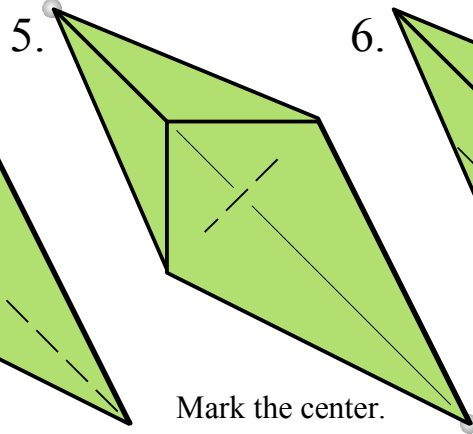

5. Mark the center.

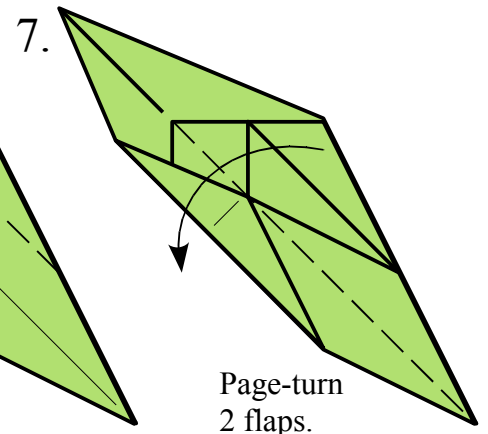
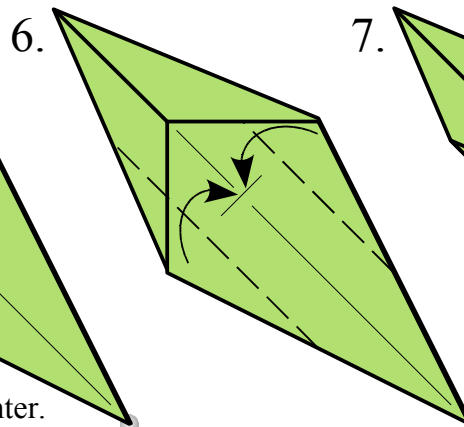

Page-turn
2 flaps.

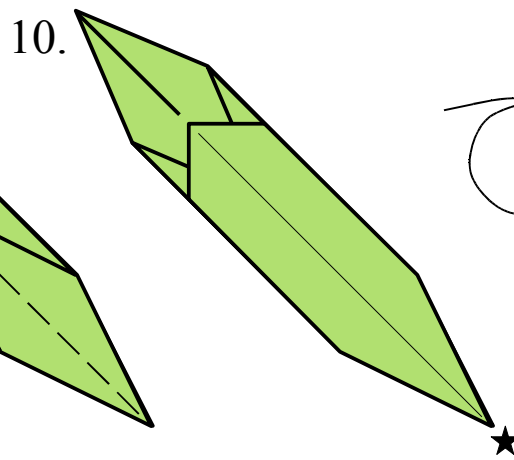
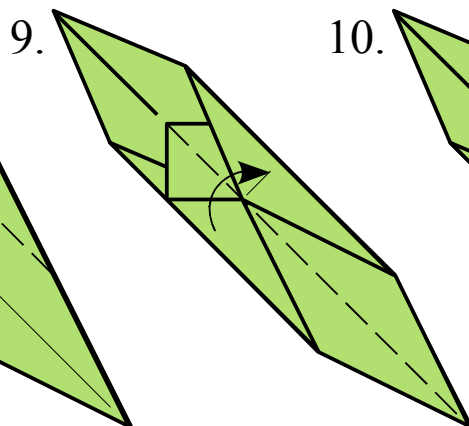
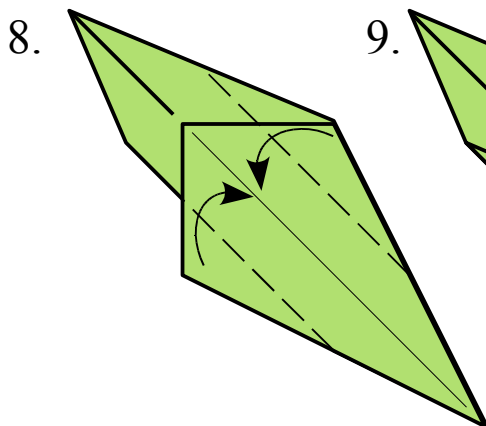

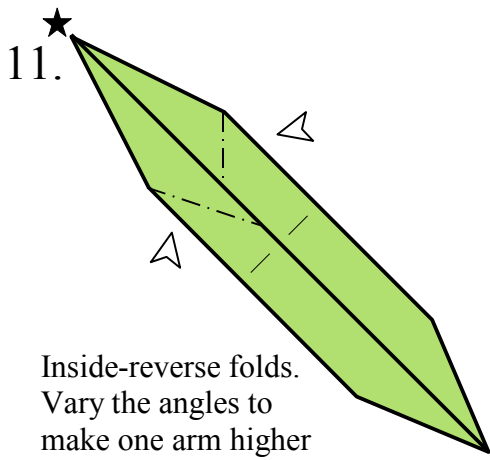

Inside-reverse folds.
Vary the angles to
make one arm higher
than the other.

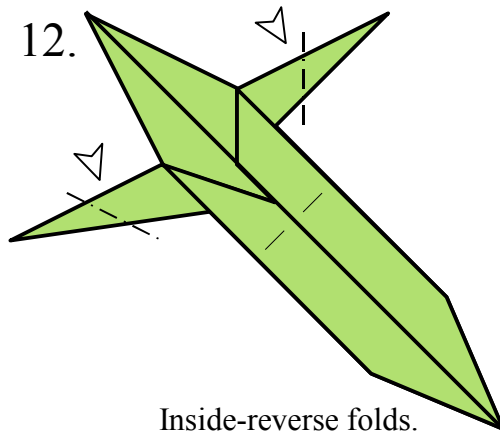

Inside-reverse folds.

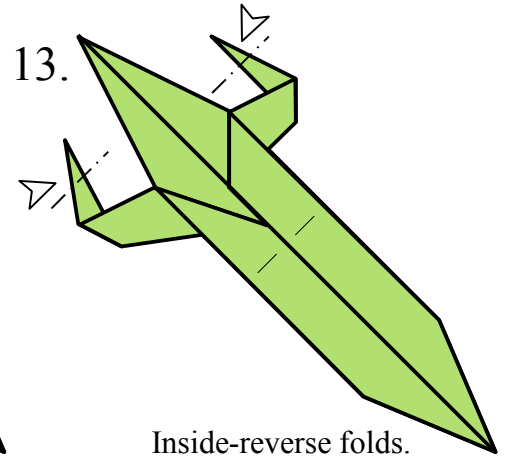

Inside-reverse folds.

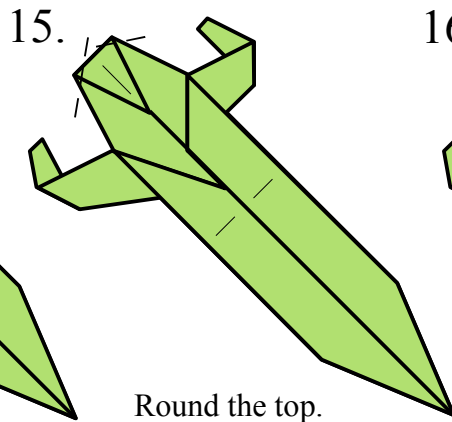
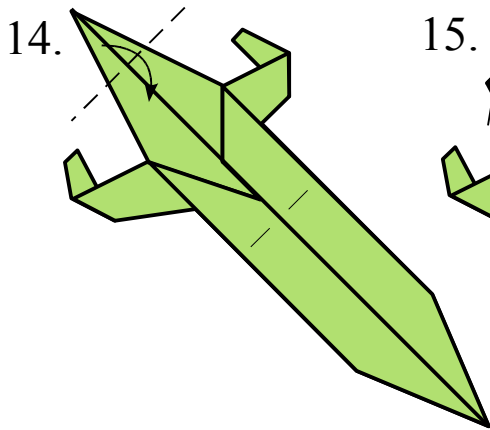

Round the top.

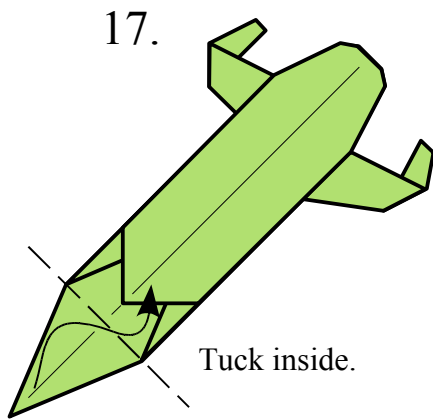
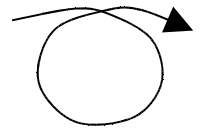
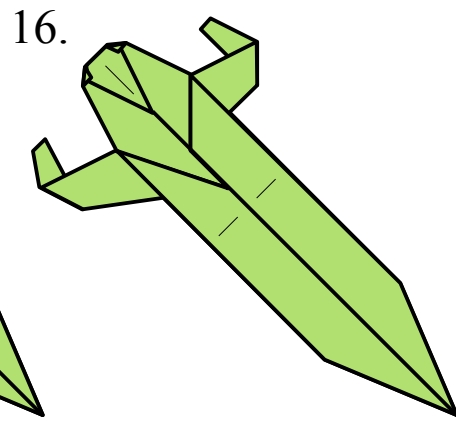

Tuck inside.

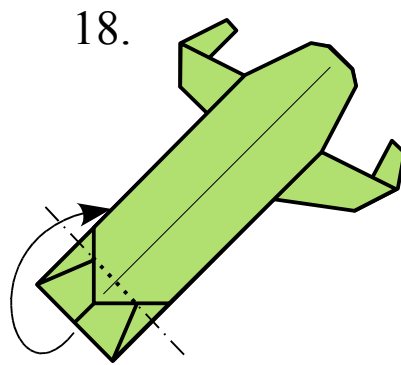

Mountain fold behind.

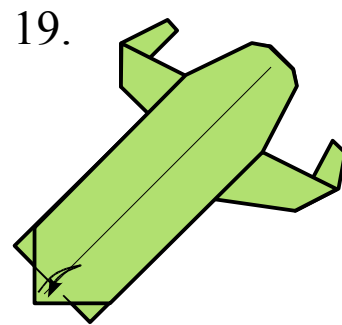

Pre-crease back and forth

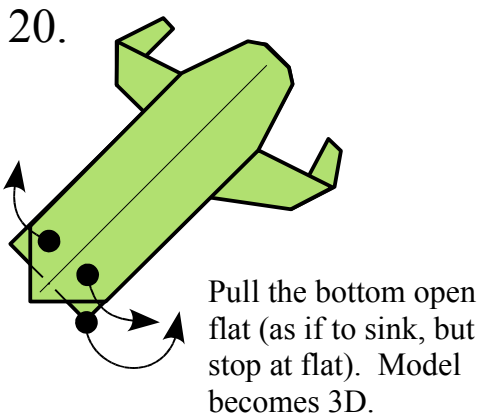

Pull the bottom open
flat (as if to sink, but
stop at flat). Model
becomes 3D.

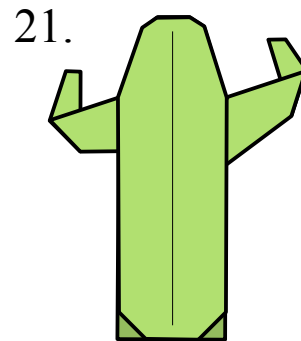
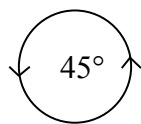

Done! Model stands upright.